

SOMMERER

Beschläge

in Schmiedeeisen,
Messing und Kupfer

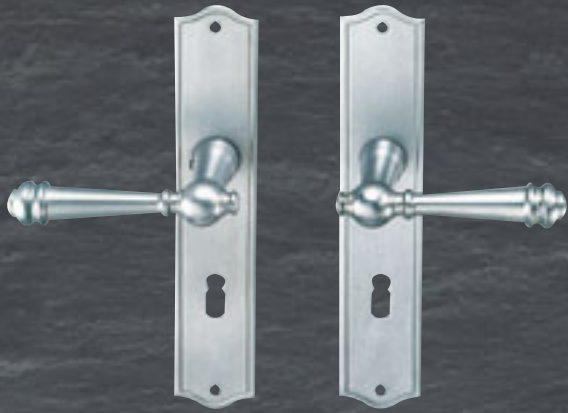



Nr. 0-117/223 ZT
Nr. 0-317/423 HT

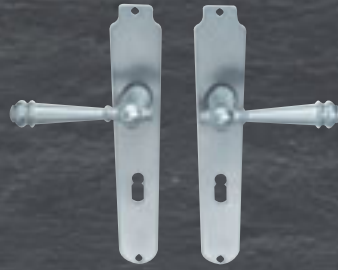

Nr. 0-117/205 ZT
Nr. 0-317/405 HT



Nr. 0-117/223 WC

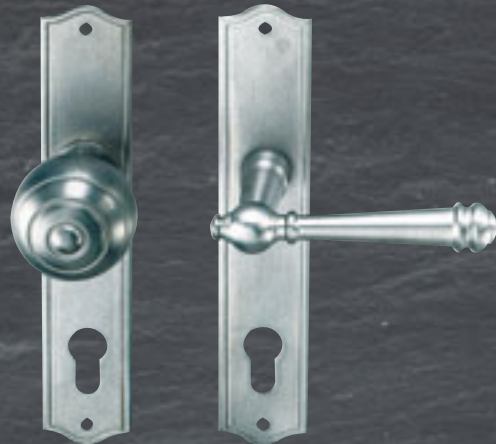

Nr. 0-117/223/223/7/55 ZT
Nr. 0-317/423/423/7/60 HT

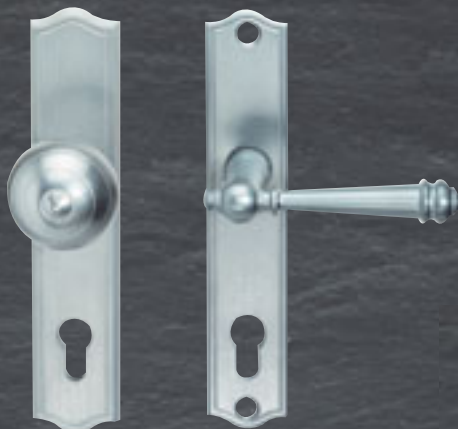

Nr. 0-423/7/60 S 117 ZT
Nr. 0-423/7/60 S 317 HT



Nr. 0-423/7/60 KS
mit Kernziehschutz

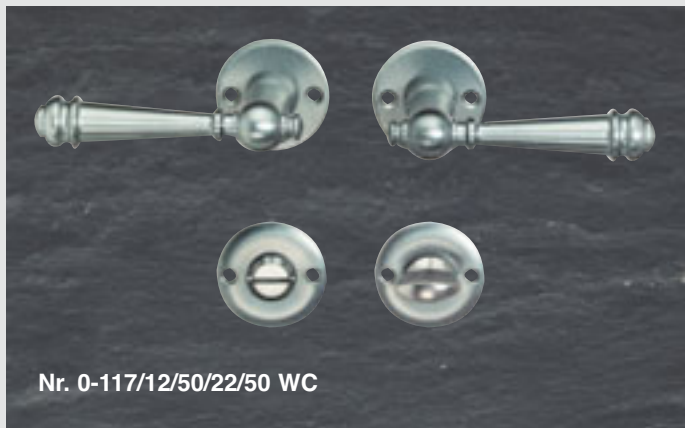

Nr. 0-117/12/50/22/50 WC

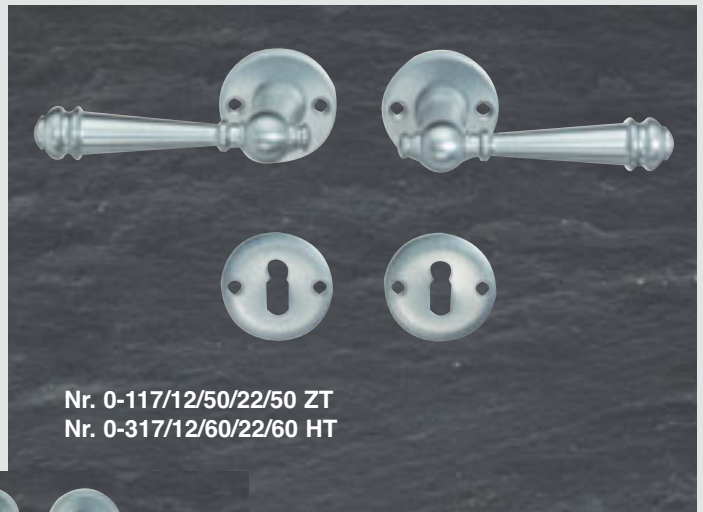

Nr. 0-117/12/50/22/50 ZT
Nr. 0-317/12/60/22/60 HT

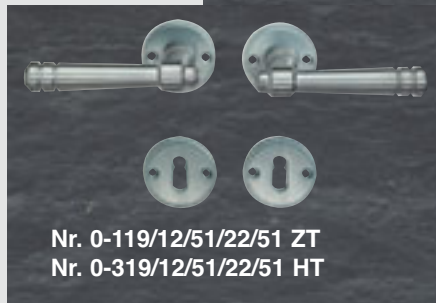

Nr. 0-119/12/51/22/51 ZT
Nr. 0-319/12/51/22/51 HT



Nr. 0-117/1/55/12/50/22/50 ZT
Nr. 0-317/1/60/12/60/22/60 HT



Nr. 0-117H/15/60F/25/60 ZT
Nr. 0-317H/15/60F/25/60 HT

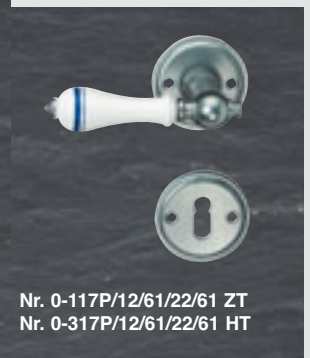

Nr. 0-117P/12/61/22/61 ZT
Nr. 0-317P/12/61/22/61 HT



Nr. 0-117/12/51/22/51 ZT
Vollmessing poliert
Nr. 0-317/12/51/22/51 HT
Vollmessing poliert



Nr. 0-117/13/65/23/65 ZT
Vollkupfer poliert
Nr. 0-317/13/65/23/65 HT
Vollkupfer poliert

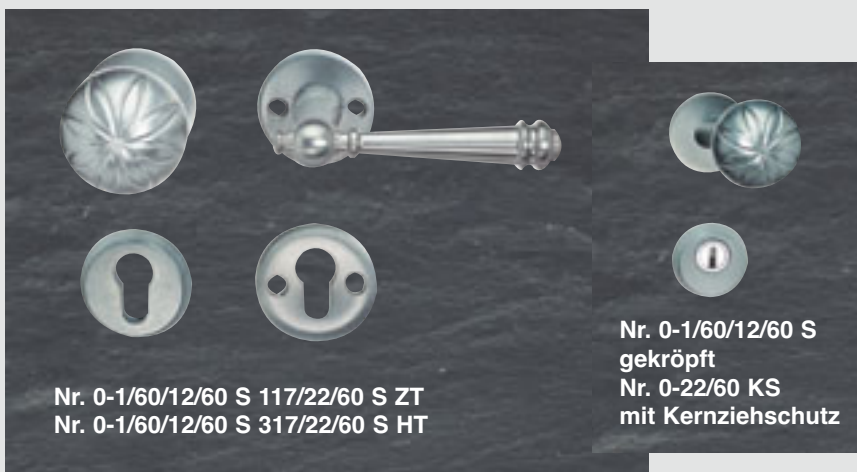

Nr. 0-1/60/12/60 S 117/22/60 S ZT
Nr. 0-1/60/12/60 S 317/22/60 S HT

Nr. 0-1/60/12/60 S
gekröpft
Nr. 0-22/60 KS
mit Kernziehschutz

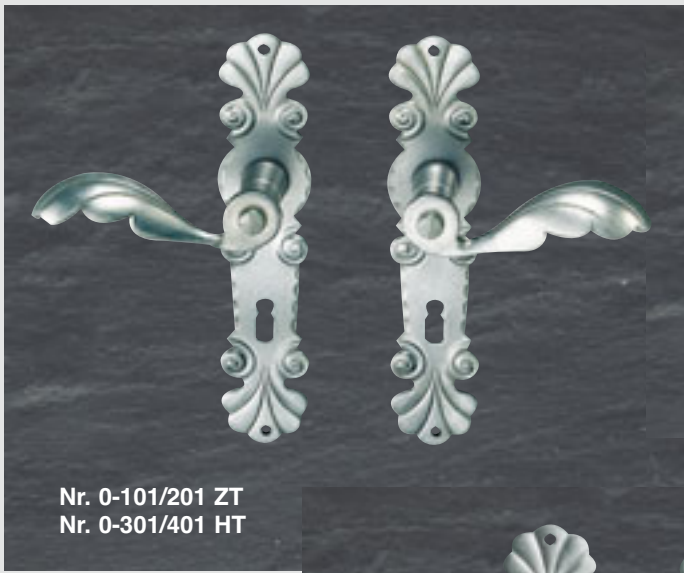

Nr. 0-101/201 ZT
Nr. 0-301/401 HT



Nr. 0-111/201 ZT
Nr. 0-311/401 HT



Nr. 0-101/201 WC



Nr. 0-101/201/201/1/55 ZT
Nr. 0-301/401/401/1/60 HT



Nr. 0-401/1/60 S 101 ZT
Nr. 0-401/1/60 S 301 HT



Nr. 0-423/1/60 KS
mit Kernziehschutz

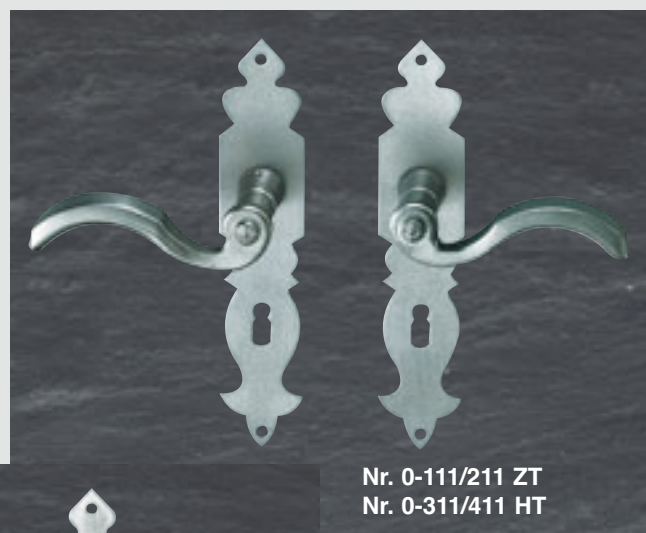



Nr. 0-101 ZT
Nr. 0-301 HT



Nr. 0-102 ZT
Nr. 0-302 HT



Nr. 0-103 ZT
Nr. 0-303 HT



Nr. 0-105 ZT
Nr. 0-305 HT



Nr. 0-201 ZT
Nr. 0-401 HT



Nr. 0-226 ZT
Nr. 0-426 HT



Nr. 0-227 ZT
Nr. 0-427 HT



Nr. 0-205 ZT
Nr. 0-405 HT



Nr. 0-11/40



Nr. 0-11/60 F



Nr. 0-11/70 F



Nr. 0-13/60



Nr. 0-21/40



Nr. 0-21/50 ZT
Nr. 0-21/60 HT



Nr. 0-21/70



Nr. 0-23/50 ZT
Nr. 0-23/60 HT



Nr. 0-1/55 ZT
Nr. 0-1/60 HT



Nr. 0-10/70 ZT
Nr. 0-10/80 HT



Nr. 0-10/75 ZT
Nr. 0-10/85 HT



Nr. 0-4/55 ZT
Nr. 0-4/60 HT



Nr. 0-110 ZT
Nr. 0-310 HT



Nr. 0-111 ZT
Nr. 0-311 HT



Nr. 0-113 ZT
Nr. 0-313 HT



Nr. 0-114 ZT
Nr. 0-313 HT



Nr. 0-210 ZT
Nr. 0-410 HT



Nr. 0-211 ZT
Nr. 0-411 HT



Nr. 0-213 ZT
Nr. 0-413 HT



Nr. 0-206 ZT
Nr. 0-406 HT



Nr. 0-16/60



Nr. 0-14/60 F



Nr. 0-12/50 ZT
Nr. 0-12/60 HT



Nr. 0-17/60



Nr. 0-26/50 ZT
Nr. 0-26/60 HT



Nr. 0-24/60



Nr. 0-22/50 ZT
Nr. 0-22/60 HT



Nr. 0-27/60



Nr. 0-7/55 ohne Rillen ZT
Nr. 0-7/60 ohne Rillen HT



Nr. 0-5/35



Nr. 0-7/55 ohne Muster ZT
Nr. 0-7/60 ohne Muster HT



Nr. 0-3/55 ZT
Nr. 0-3/60 HT



Nr. 0-115 ZT
Nr. 0-315 HT



Nr. 0-117 ZT
Nr. 0-317 HT



Nr. 0-117 P ZT
Nr. 0-317 P HT



Nr. 0-117 H ZT
Nr. 0-317 H HT



Nr. 0-217 ZT
Nr. 0-417 HT



Nr. 0-223 ZT
Nr. 0-423 HT



Nr. 0-222 ZT
Nr. 0-422 HT



Nr. 0-221 ZT
Nr. 0-421 HT



Nr. 0-15/60 F



Nr. 0-12/61



Nr. 0-12/51



Nr. 0-13/55 ZT
Nr. 0-13/65 HT



Nr. 0-25/50 ZT
Nr. 0-25/60 HT



Nr. 0-22/61



Nr. 0-22/51



Nr. 0-23/55 ZT
Nr. 0-23/65 HT



Nr. 0-1/55/11/70 ZT
Nr. 0-1/60/11/70 HT



Nr. 0-2/55 ZT
Nr. 0-2/60 HT



Nr. 0-7/55 ZT
Nr. 0-7/60 HT



Nr. 0-2/70



Nr. 0-119 ZT
Nr. 0-319 HT



Nr. 0-120 ZT
Nr. 0-320 HT

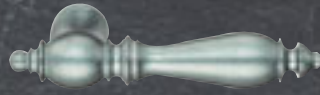

Nr. 0-133 ZT
Nr. 0-333 HT



Nr. 0-134 ZT
Nr. 0-334 HT



Nr. 0-224 ZT
Nr. 0-424 HT



Nr. 0-209 ZT
Nr. 0-409 HT



Nr. 0-220 ZT
Nr. 0-420 HT



Nr. 0-215 ZT
Nr. 0-415 HT



Nr. 0-16/80



Nr. 0-19/64



Nr. 0-18/60

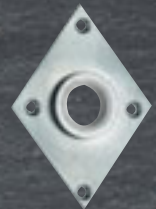

Nr. 0-20/70



Nr. 0-26/80



Nr. 0-29/64



Nr. 0-28/60



Nr. 0-30/70



Nr. 0-9/60



Nr. 0-4/64



Nr. 0-5/35



Nr. 0-8/60

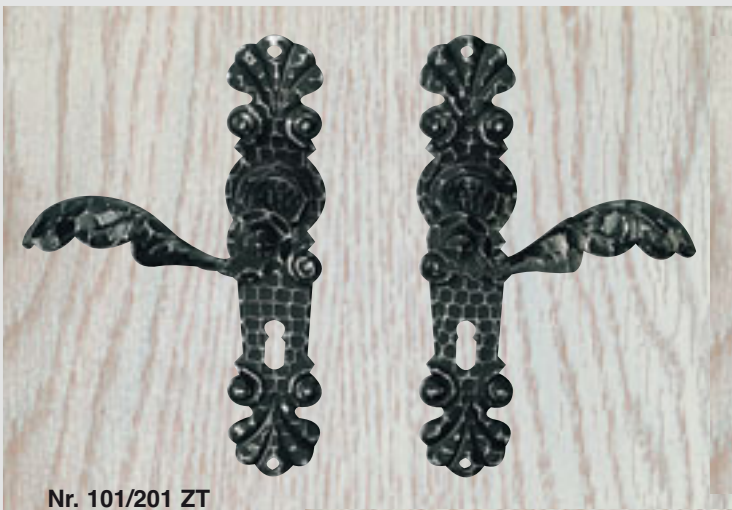

Nr. 101/201 ZT
Nr. 301/401 HT



Nr. 103/201 ZT
Nr. 303/401 HT



Nr. 101/201 WC



Nr. 101/201/201/1/55 ZT
Nr. 301/401/401/1/60 HT



Nr. 401/1/60 S 101 ZT
Nr. 401/1/60 S 301 HT



Nr. 401/1/60 KS
mit Kernziehschutz

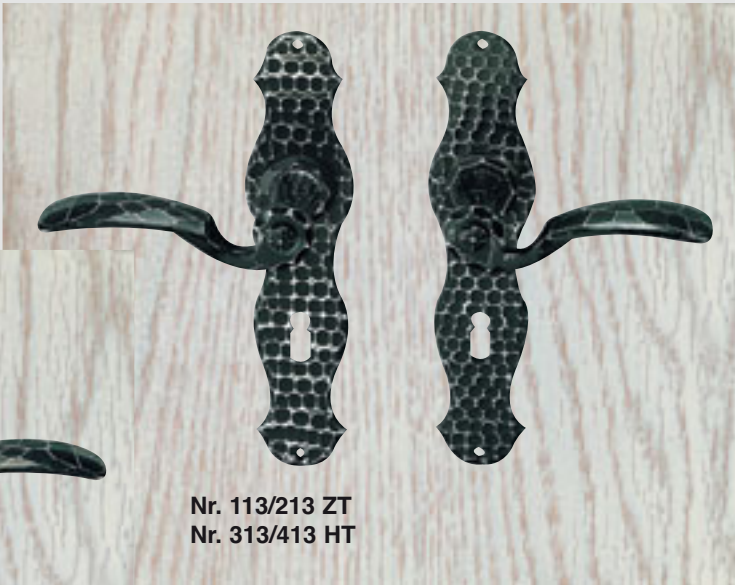

Nr. 113/213 ZT
Nr. 313/413 HT

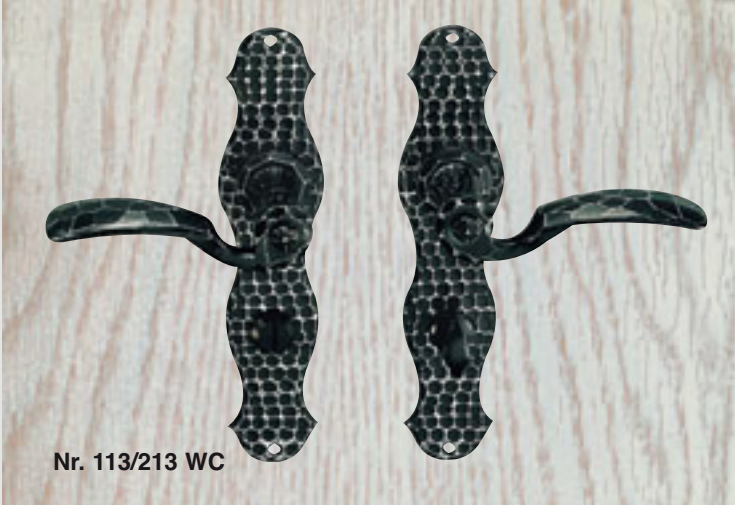

Nr. 113/213 WC



Nr. 113/213/213/2/55 ZT
Nr. 313/413/413/2/60 HT

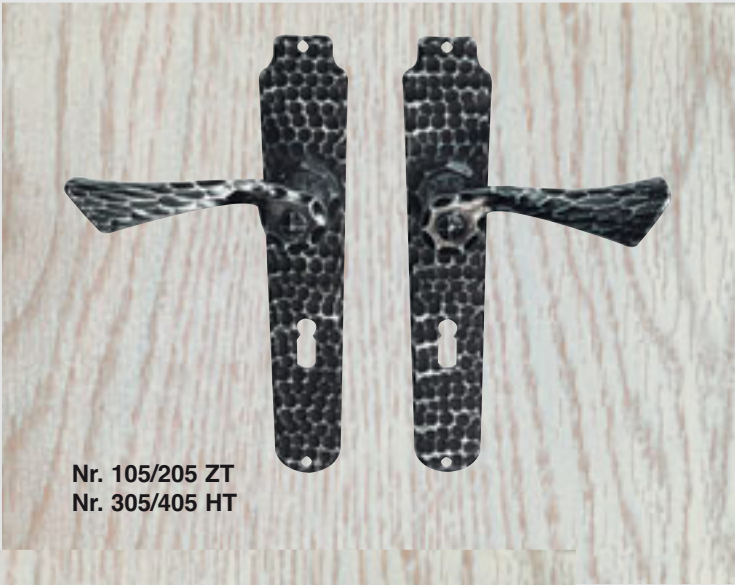

Nr. 105/205 ZT
Nr. 305/405 HT



Nr. 105/205/205/4/55 ZT
Nr. 305/405/405/4/60 HT



Nr. 105/205 WC



Nr. 101 ZT
Nr. 301 HT



Nr. 102 ZT
Nr. 302 HT



Nr. 103 ZT
Nr. 303 HT



Nr. 104 ZT
Nr. 304 HT



Nr. 201 ZT
Nr. 401 HT



Nr. 205 ZT
Nr. 405 HT



Nr. 211 ZT
Nr. 411 HT



Nr. 204 ZT
Nr. 404 HT



Nr. 12/50 ZT
Nr. 12/60 HT



Nr. 13/60



Nr. 11/60



Nr. 11/40



Nr. 22/50 ZT
Nr. 22/60 HT



Nr. 23/50 ZT
Nr. 23/60 HT



Nr. 21/50 ZT
Nr. 21/60 HT



Nr. 21/40



Nr. 1/55 ZT
Nr. 1/60 HT



Nr. 2/55 ZT
Nr. 2/60 HT



Nr. 10/70 ZT
Nr. 10/80 HT



Nr. 10/75 ZT
Nr. 10/85 HT



Nr. 105 ZT
Nr. 305 HT



Nr. 113 ZT
Nr. 313 HT



Nr. 116 ZT
Nr. 316 HT



Nr. 122 ZT
Nr. 322 HT



Nr. 206 ZT
Nr. 406 HT



Nr. 213 ZT
Nr. 413 HT



Nr. 216 ZT
Nr. 416 HT



Nr. 226 ZT
Nr. 426 HT



Nr. 17/60



Nr. 16/60



Nr. 20/60



Nr.14/60

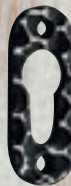

Nr. 27/60



Nr. 26/60



Nr. 30/60



Nr. 24/60



Nr. 3/55 ZT
Nr. 3/60 HT



Nr. 4/55 ZT
Nr. 4/60 HT



Nr. 6/55 ZT
Nr. 6/60 HT



Nr. 4/64



Briefe

O. Wolf



**Unsere Artikel können Sie über jeden
Beschlag-Eisenwarenfachhandel Ihrer Wahl beziehen.
Informieren Sie sich bei Ihrem Fachhändler!**



**SOMMERER-Beschläge
Waltraud Sommerer
Kunstschmiedearbeiten**

**Johann-Feilner-Str. 9 · 95511 Mistelbach
Tel. 092 01/10 52 · Fax 092 01/6 02
verkauf@sommerer-beschlaege.de
www.sommerer-beschlaege.de**